

311

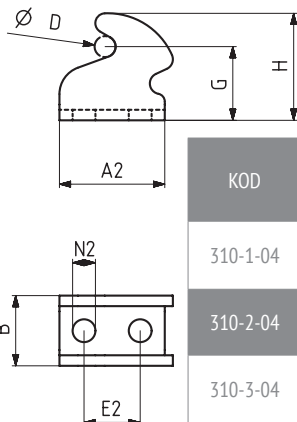

KOD	MODELLO NR	INOX	NERO (NOIR)	PESO (POIDS) (gr ±%)	A2	B	D	G	H	E2	N2
310-1-04	311-312-321-331-332-351-1	S310-1-04	B310-1-04	12	24,5	15,5	Ø 3,5	12,5	19	10	Ø 5
310-2-04	311-312-331-332-351-2	S310-2-04	B310-2-04	19	28,5	15,5	Ø 3,5	16,5	23	12	5,5 x 7,5
310-3-04	311-312-331-332-351-421-3	S310-3-04	B310-3-04	36	30	20	Ø 5,5	21	30,5	16	Ø 6,5
310-4-04	311-312-331-332-351-4-5 371-4	S310-4-04	B310-4-04	86	45	28	Ø 7	27	39	19,5	8,5 x 10

Piastra di Aggancio
Attaches

311

Gancio a U
Crochet U

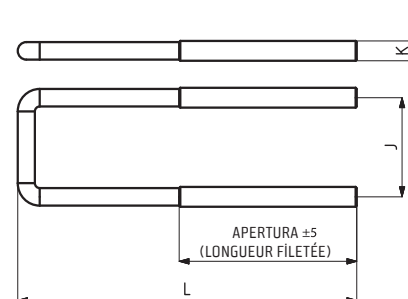

KOD	MODELLO NR	INOX	NERO (NOIR)	PESO (POIDS) (gr ±%)	J	K	L	apertura (Longueur filetée)
150 - 63	*311-312-321-331-332-351-1 311-312-331-332-351-2*	S 150 - 63	B 150 - 63	14	23	M4	90	45
150 - 591	*311-312-321-331-332-351-1-1 311-312-331-332-351-2*	S 150 - 591	B150 - 591	12	23	M4	75	45
150 - 155	*311-312-321-331-332-351-1 311-312-331-332-351-2*	S 150 - 155	B 150 - 155	22	23	M4	140	45
150 - 08	311-312-331-332-351-3	S 150 - 08	B 150 - 08	39	30	M6	105	75
150 - 156	311-312-331-332-351-3	S 150 - 156	B 150 - 156	56	30	M6	155	75
150 - 34	311-312-331-332-351-4-341-3	S 150 - 34	B 150 - 34	101	43	M8	145	95
150 - 198	311-312-331-332-351-4	S 150 - 198	B 150 - 198	135	43	M8	195	65
150 - 35	311-312-331-332-351-4	S 150 - 35	B 150 - 35	187	43	M8	295	85
150-539	311-312-331-332-351-4	-	-	175	43	M8	250	80,5
150 - 148	341-4	-	-	222	50	M10	210	130
150-512	341-4	-	-	260	50	M10	260	130
150 - 650	371-4	-	B150 - 650	85	43	M8	120	65
150 - 141	311-312-331-332-351-5	-	B 150 - 141	200	45	M10	180	110
150 - 200	311-312-331-332-351-5	-	B 150 - 200	257	45	M10	258	130
150-516	311-312-331-332-351-5	-	B 150 - 516	240	45	M10	230	130
150 - 285	341-5	-	-	229	54	M12	146	65

Nuovo

341

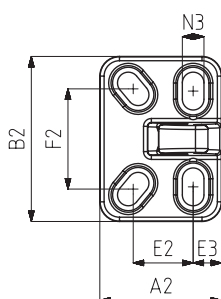
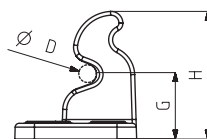

KOD	MODELLO NR	PESO (POIDS) (gr ±%)	A2	B2	D	G	H	E2	F2	N3
340-3-03	341-3	210	49,5	67	Ø 8	27	52,5	24,5	41	8,5 x 14,5
340-4-03	341-4	400	62	84	Ø 10	33,5	65	30,5	51	11 x 19
340-5-03	341-5	510	66	84	Ø 12	33,5	65	31,5	51	11 x 19

Piastra di Aggancio
Attaches

361

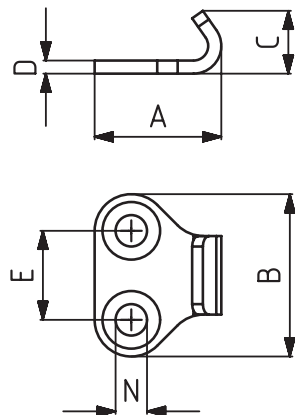

KOD	MODELLO NR	INOX	PESO (POIDS) (gr ±%)	A	B	C	D	E	N
361-1-03	361-362-1	S 361 -1 -03	6	19,5	24,5	10	2	14	Ø 5
361-2-03	361-362-2-2-K	S 361 -2 -03	14	24	31	12	2,5	17	Ø 6
361-3-03	361-362-3-3-K	S 361 -3 -03	26	27	40	15	3	22	Ø 6

Piastra di Aggancio
Attaches

361

Gancio
Crochet

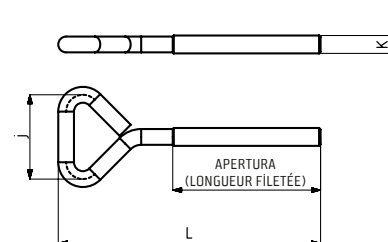

KOD	MODELLO NR	INOX	PESO (POIDS) (gr ±%)	J	K	L	apertura (Longueur filetée)
150 - 697	361 - 1	S 150-697	12	20	M5	50	23
150 - 267	361 - 2 - 361-2-K	S 150-267	24	28	M6	88,5	50
150 - 642	361 - 3 - 361-3-K	S 150-642	56	40	M8	95	40

362

Gancio
Crochet

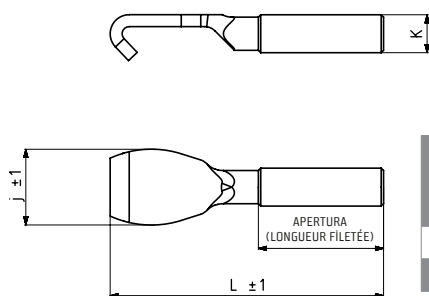

KOD	MODELLO NR	INOX	PESO (POIDS) (gr ±%)	J	K	L	apertura (Longueur filetée)
150 - 270	362-1	S 150-270	10	10,5	M6	57	25
150 - 498	362-2	S 150-498	20	14	M8	57,5	25

363

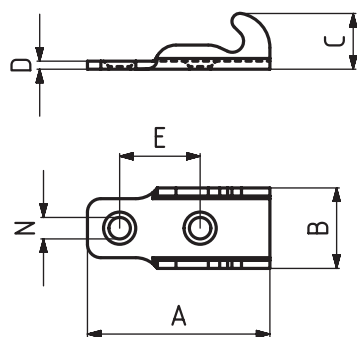

KOD	MODELLO NR	INOX	PESO (POIDS) (gr ±%)	A	B	C	D	E	N
363-2-03	363-2	S 363-2-03	6	34	15	10,5	1,5	15	Ø 4

Piastra di Aggancio
Attaches

363

new

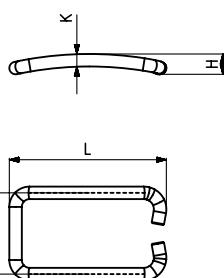

KOD	MODELLO NR	INOX	PESO (POIDS) (gr ±%)	H	J	K	L
150 - 269	363-2	S 150-269	12	6,5	26	Ø4	50

Gancio
Crochet

411

Gancio a C
Crochet C

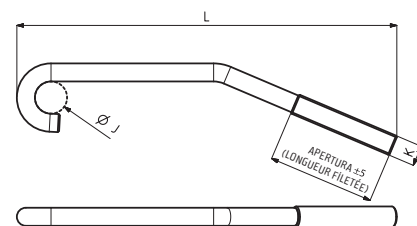

KOD	MODELLO NR	INOX	NERO (NOIR)	PESO (POIDS) (gr ±%)	J	K	L	apertura (Longueur filetée)
150-69	411-412-2	S 150-69	B 150-69	23	9	M6	122	50
150-13	411-412-413-3	S 150-13	B 150-13	54	12,5	M8	152	40
150-44	411-412-4	-	B 150-44	110	16	M10	197	55

421

Gancio a C
Crochet C

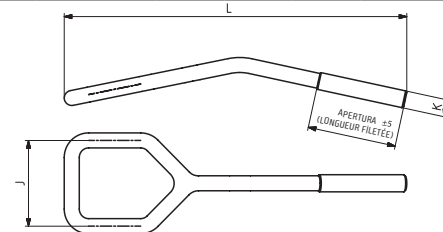

KOD	MODELLO NR	INOX	NERO (NOIR)	PESO (POIDS) (gr ±%)	J	K	L	apertura (Longueur filetée)
150-139	421-3	S 150-139	B 150-139	77	40	M8	159	40

510

Dado
Erou

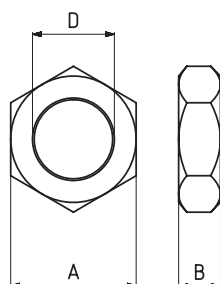

KOD	MODELLO NR	INOX	NERO (NOIR)	PESO (POIDS) (gr ±%)	A	B	D
150-327	511-0	S 511-....	B 511-....	11	17	6	M10 x 1
150-103	511-512-513-1	S 511-....	B 511-....	14	19	7	M12 x 1,5
150-74	511-512-513-2	S 511-....	B 511-....	19	24	8	M16 x 1,5
150-21	511-512-513-3	-	B 511-....	29	30	9	M20 x 1,5
150-50	511-512-513-5-6	-	B 511-....	62	36	10	M24 x 1,5

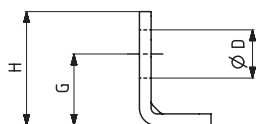

511

Base Orizzontale
Base Horizontale

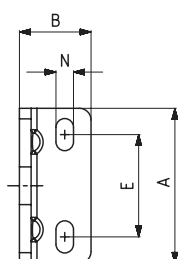

KOD	MODELLO NR	INOX	NERO (NOIR)	PESO (POIDS) (gr ±%)	A	B	Ø D	E	G	H	N
510-1-01	511-1	S 511-....	B 511-....	36	44	20	12,5	26,5	19,5	30,5	5,5 x 10,5
510-2-01	511-2	S 511-....	B 511-....	72	53	24,5	16,5	35	24,5	39	6 x 11
510-3-01	511-3	-	B 511-....	122	60	30	20,5	38	30,5	48	6,5 x 11
510-5-01	511-5 / 511-6	-	B 511-....	250	78	36	24,5	49,5	38	61	8,5 x 16

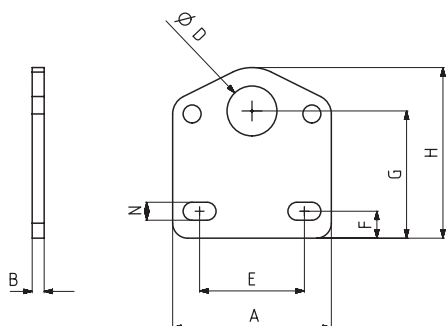

512

Base Verticale
Base Verticale



KOD	MODELLO NR	INOX	NERO (NOIR)	PESO (POIDS) (gr ±%)	A	B	Ø D	E	F	G	H	N
510-1-02	512-1	S 512-....	B 512-....	40	44	3	12,5	26,5	8,5	35	46	5,5 x 10,5
510-2-02	512-2	S 512-....	B 512-....	74	53	4	16,5	35	9	42,5	57	6 x 11
510-3-02	512-3	-	B 512-....	124	60	5	20,5	38	12,5	52	69	6,5 x 11
510-5-02	512-5 / 512-6	-	B 512-....	250	78	6	24,5	49,5	15	64,5	87,5	8,5 x 16

911

Puntali in Gomma Siliconica
Presseur Silicone

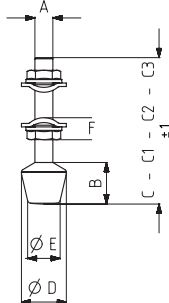

KOD	MODELLO NR	INOX	NERO (NOIR)	Zincato nero (Galvanisé noir)	PESO (POIDS) (gr ±%)	Vite DIN 933 (Tige DIN 933)	B	C	C1	C2	C3	D	E	F
150-181	911-0	S 911-...	B 911-...	BG 911-...	7	M 4 x 25	7	31	-	-	-	10	8	6
150-547	911-0-C1	S 911-...	B 911-...	-	8	M 4 x 60	7	-	65,5	-	-	10	8	6
150-99	911-1	S 911-...	B 911-...	BG 911-...	12	M 5 x 35	10,5	43,5	-	-	-	12,5	9	7
150-545	911-1-C1	S 911-...	B 911-...	-	14	M 5 x 60	10,5	-	68,5	-	-	12,5	9	7
150-86	911-2	S 911-...	B 911-...	BG 911-...	23	M 6 x 40	14,5	50,5	-	-	-	16	10,5	8
150-245	911-2-C1	S 911-...	B 911-...	-	34	M 6 x 100	14,5	-	110,5	-	-	16	10,5	8
150-246	911-2-C2	S 911-...	B 911-...	-	41	M 6 x 120	14,5	-	-	130,5	-	16	10,5	8
150-546	911-2-C3	S 911-...	B 911-...	-	28	M 6 x 60	14,5	-	-	-	70,5	16	10,5	8
150-87	911-3	S 911-...	B 911-...	BG 911-...	46	M 8 x 50	18	63,5	-	-	-	20	14	10
150-247	911-3-C1	S 911-...	B 911-...	-	55	M 8 x 70	18	-	83,5	-	-	20	14	10
150-283	911-3-C2	S 911-...	B 911-...	-	75	M 8 x 130	18	-	-	143	-	20	14	10
150-641	911-3-C3	S 911-...	B 911-...	-	22	M 8 x 35	18	-	-	-	48,5	20	14	10
150-88	911-4	-	B 911-...	BG 911-...	97	M 10 x 70	23,5	87	-	-	-	26,5	17	13
150-217	911-4-C1	-	B 911-...	-	116	M 10 x 110	23,5	-	125	-	-	26,5	17	13
150-116	911-5	-	B 911-...	BG 911-...	156	M 12 x 80	27,25	100	-	-	-	30	21	15
150-354	911-5-C1	-	B 911-...	-	174	M 12 x 110	27,25	-	130	-	-	30	21	15

BG911 NR

Puntali in Gomma Naturale
Presseur Caoutchouc

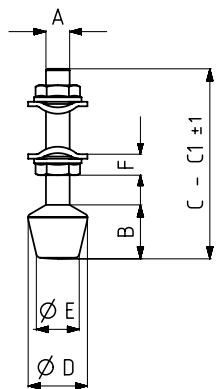

KOD	MODELLO NR	PESO (POIDS) (gr ±%)	Vite DIN 933 (Tige DIN 933)	B	C	D	E	F
BG150-181-NR	BG911-0-NR	7	M 4 x 25	7	31	10	8	6
BG150-99-NR	BG911-1-NR	12	M 5 x 35	10,5	43,5	12,5	9	7
BG150-86-NR	BG911-2-NR	23	M 6 x 40	14,5	50,5	16	10,5	8
BG150-546-NR	BG911-2-C3-NR	28	M 6 x 60	14,5	70,5	16	10,5	8
BG150-87-NR	BG911-3-NR	46	M 8 x 50	18	63,5	20	14	10
BG150-88-NR	BG911-4-NR	97	M 10 x 70	23,5	87	26,5	17	13
BG150-116-NR	BG911-5-NR	156	M 12 x 80	27,25	100	30	21	15

M911

Puntali Metallici
Presseur Métallique



Nuovo

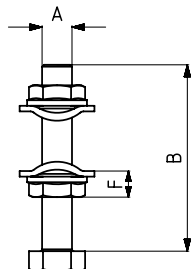

KOD	MODELLO NR	INOX	NERO (NOIR)	PESO (POIDS) (gr ±%)	A CIVATA DIN 933 (SCREW DIN 933)	B	F
150-181-324-00	M911-0	S M911-...	B M911-...	7	M 4 X 25	25	6
150-99-263-00	M911-1	S M911-...	B M911-...	12	M 5 X 35	35	7
150-86-264-00	M911-2	S M911-...	B M911-...	23	M 6 X 40	40	8
150-87-265-00	M911-3	S M911-...	B M911-...	42	M 8 X 50	50	10
150-88-266-00	M911-4	-	B M911-...	89	M 10 X 70	70	13
150-116-328-00	M911-5	-	B M911-...	145	M 12 X 80	80	15

912

Puntali Metallici Orientabili
Presseur Métallique Orientable
BREVETTO NR(BREVETE N°): 20100115

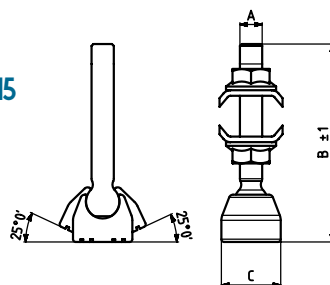

MODELLO NR	ANGOLO (ANGLE)	PESO (POIDS) (gr ±%)	A	B	C
912-2	25°	36	M6	53,5	Ø15
912-3	25°	70	M8	63,5	Ø20
912-4	25°	149	M10	90	Ø26
912-5	25°	223	M12	103	Ø30

913

Metal V Mafsal Ug
V Grooved Swivel Metal Squeeze Part
BREVETTO NR(BREVETE N°): 20100115

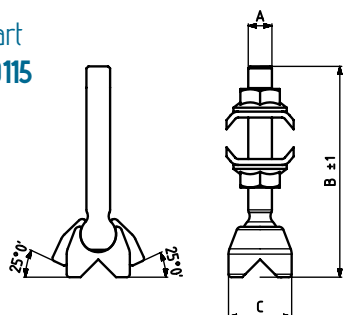

MODELLO NR	ANGOLO (ANGLE)	PESO (POIDS) (gr ±%)	A	B	C
913-2	25°	32	M6	53,5	Ø15
913-3	25°	66	M8	63,5	Ø20
913-4	25°	142	M10	90	Ø26
913-5	25°	212	M12	103	Ø30

914

Vite di Regolazione, Base Zigrinata
Presseur Métallique Orientable
BREVETTO NR(BREVETE N°): 20100115

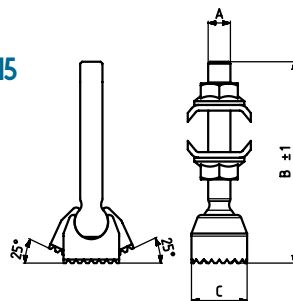

MODELLO NR	ANGOLO (ANGLE)	PESO (POIDS) (gr ±%2)	A	B	C
914 - 2	25°	33	M6	53,5	Ø15
914 - 3	25°	69	M8	63,5	Ø20
914 - 4	25°	148	M10	90	Ø26
914 - 5	25°	222	M12	103	Ø30

915

Puntali Metallici BREVETTO NR(BREVETE N°) 20100115
Presseur Métallique Fixe

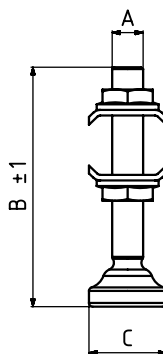

MODELLO NR	PESO (POIDS) (gr ±%2)	A	B	C
915 - 1	8	M5	43	Ø14
915 - 2	15	M6	53,5	Ø16
915 - 3	53	M8	64,5	Ø20
915 - 4	105	M10	86	Ø25
915 - 5	182	M12	98	Ø30

150-623

Puntali in NBR
Presseur NBR

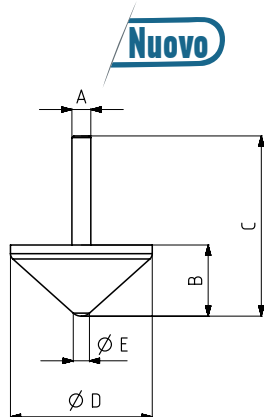

KOD	MODELLO NR	INOX	PESO (POIDS) (gr ±%2)	A CIVATA DIN 933 (SCREW DIN 933)	B	C	D	E
150 - 623	510-520-530-550-620-640-660-670-3	S150 - 623	155	M8 x 50	30	76	60	6,5

916

Puntali in Gomma Siliconica
Presseur Silicone



KOD	MODELLO NR	INOX	NERO (NOIR)	PESO (POIDS) (gr ±%2)	A CIVATA DIN 933 (SCREW DIN 933)	B	C	C1	D	E	F
150 - 324	916 - 0	S 916 -	B 916 -	6	M4 x 25	5	29	-	10	9	6
150 - 526	916 - 0 - C1	S 916 -	B 916 -	10	M4 x 60	5		63,9	10	9	6
150 - 263	916 - 1	S 916 -	B 916 -	16	M 5 x 35	7	40	-	12	10	7
150 - 588	916 - 1 - C1	S 916 -	B 916 -	16	M 5 x 60	7		65	12	10	7
150 - 264	916 - 2	S 916 -	B 916 -	23	M 6 x 40	10	46	-	16	13	8
150 - 265	916 - 3	S 916 -	B 916 -	46	M 8 x 50	12	57	-	20	16	10
150 - 266	916 - 4	-	B 916 -	98	M10 x 70	16	79	-	26	20	13
150 - 328	916 - 5	-	B 916 -	152	M12 x 80	19	91	-	30	24	15

917

Puntali in Silicone Con Molla
Presseur Silicone à Ressort

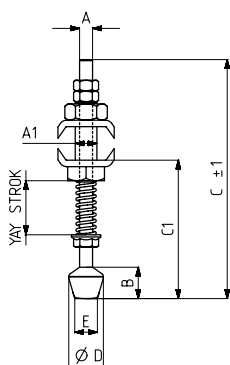

KOD	MODELLO NR	NERO (NOIR)	CORSA DELLA MOLLA	PESO (POIDS) (gr ±%2)	A CIVATA DIN 933 (SCREW DIN 933)	A1	B	C	C1	D	E
150 - 545	917 - 3	B 917 -	8	37	M 5 x 60	M8	10,5	68,5	35,5	12,5	9
150 - 246	917 - 4	B 917 -	14	82	M 6 x 120	M10	14,5	130,5	55 - 93,5	16	10,5
150 - 283	917 - 5	B 917 -	19	140	M 8 x 130	M12	18	143	69-88	20	14

918

Puntali Metallici Con Molla
Presseur Métallique à Ressort

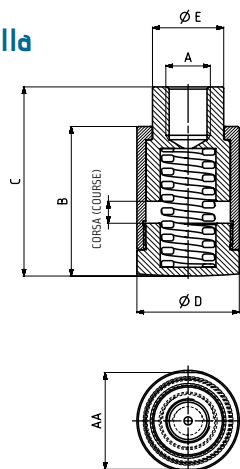

MODELLO NR	F1 (N)	STROK	PESO (POIDS) (gr ±%)	A	AA	B	C MIN.	C MAX.	ØD	ØE
918 - 3	200	5	96	M8	22	34	38	43	23	16
918 - 4	250	5	93	M10	22	34	38	43	23	16
918 - 5	300	5	91	M12	22	34	38	43	23	16

921

Manopola in Plastica
Poignée Polyuréthane

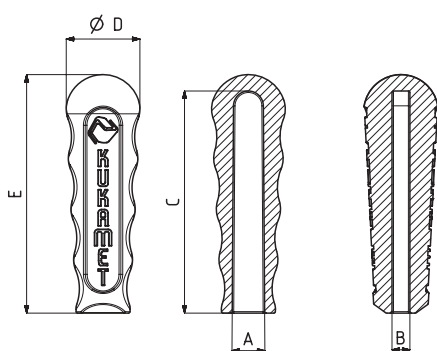

MODELLO NR	NERO (NOIR)	PESO (POIDS) (gr ±%)	A	B	C	D	E
921 - 0	B 921 -	1	6,5	3	26,5	10,5	29
921 - 1	B 921 -	8	11	4	54	17,5	58
921 - 2	B 921 -	15	11	5	54	23	60
921 - 3	B 921 -	27	11	6	74	25	80
921 - 4	B 921 -	49	18	6	94	29	100
921 - 4	B 921 -	49	18	8	94	29	100
921 - 4	B 921 -	49	18	10	94	29	100



921-M

Impugnatura Metallica
Poignée Métallique

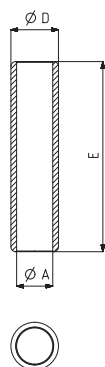

KOD	MODELLO NR	PESO (POIDS) (gr ±%)	A	D	E
921-1-2-M	110-210-310-330-410-510-710-810 - 1 - 2	44	12	16	60
921-1-2-M-C1	222-232-820 - 2	54	12	16	110
921-3-M	110-210-310-330-410-510-710-810 - 3	57	12	18	80
921-3-M-C1	110-210-310-330-410-510-710-810 - 3	90	12	18	130
921-4-M	110-210-310-330-410-4 / 110-210-310-5	164	19	25	100
921-4-M-C1	110-210-310-330-410-4 / 110-210-310-5	241	19	25	150

931

Staffa a Doppio Puntale
Presseur à Double Points

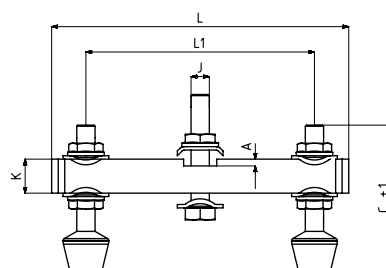

MODELLO NR	NERO (NOIR)	PESO (POIDS) (gr ±%)	A	C	L	L1	J	K
931 - 1	B 931 -	60	2,5	43,5	90	30 - 70	M5	10
931 - 2	B 931 -	142	2,5	50,5	110	30 - 80	M6	16
931 - 3	B 931 -	289	3	63,5	130	40 - 100	M8	20
931 - 4	B 931 -	463	4	87	160	50 - 120	M10	20
931 - 5	B 931 -	774	5	100	180	60 - 140	M12	25

941-G

Porta Bussola
Porte Tige

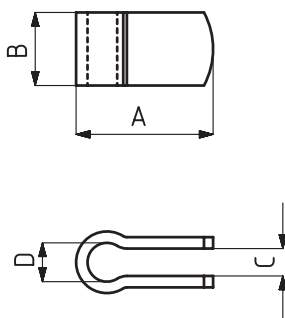

MODELLO NR	NERO (NOIR)	Puntali in gomma siliconica (Presseur silicone)	PESO (POIDS) (gr ±%2)	A	B	C	D
941 - 1 - G	B 941 -	M5	6	25	10	5	Ø 6,5
941 - 2 - G	B 941 -	M6	10	25	13	5	Ø 6,5
941 - 2 - C1 - G	B 941 -	M6	16	35	13	6,5	Ø 6,5
941 - 3 - G	B 941 -	M8	20	30	16	6	Ø 8,5
941 - 4 - G	B 941 -	M10	35	37	20	8	Ø 10,5
941 - 5 - G	B 941 -	M12	61	40	25	10	Ø 12,5

951-G

Bussola Filettata
Douille Filetée

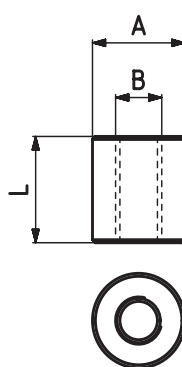

MODELLO NR	NERO (NOIR)	PESO (POIDS) (gr ±%2)	A	B	L
951 - 1 - G	B 951 -	6	Ø 10	M5	12
951 - 2 - G	B 951 -	10	Ø 12	M6	15
951 - 3 - G	B 951 -	23	Ø 16	M8	18
951 - 4 - G	B 951 -	32	Ø 18	M10	22
951 - 5 - G	B 951 -	44	Ø 20	M12	27
951 - 6 - G	B 951 -	94	Ø 25	M12	32



961

Piastra di Aggancio
Attaches

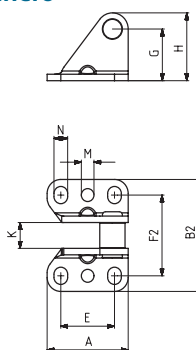

KOD	MODELLO NR	INOX	NERO (NOIR)	PESO (POIDS) (gr ±%2)	A	E	G	H	K	M	N	F2	B2
961 - 2	411 - 2	S 961 -	B 961 -	50	31	15	26	31,5	10	-	6 x 9,5	32,5	47
961 - 3	411 - 3	S 961 -	B 961 -	65	38,5	22	24	31,5	12	-	7 x 10	37,5	52
961 - 4	411 - 4	-	B 961 -	210	50	30	40	49	16	8,5	10,5 x 15	60,5	84



962

Piastra di Aggancio
Attaches

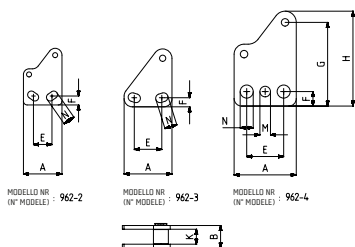

KOD	MODELLO NR	INOX	NERO (NOIR)	PESO (POIDS) (gr ±%2)	A	B	E	F	G	H	K	M	N
962 - 2	412 - 2	S 962 -	B 962 -	51	31	15	15	7	40	45,5	10	-	6 x 9,5
962 - 3	412 - 3	S 962 -	B 962 -	65	38,5	18	22	7,3	39	46,5	12	-	7 x 10
962 - 4	412 - 4	-	B 962 -	220	50	24	30	11,5	67	76	16	8,5	Ø10,5



963

Piastra di Aggancio
Attaches

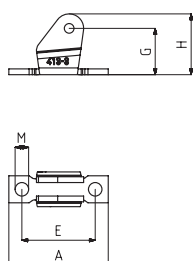

KOD	MODELLO NR	INOX	NERO (NOIR)	PESO (POIDS) (gr ±%2)	A	E	M	G	H
963-3	413-3	S 963 -	B 963 -	46	51,5	38	7	24	31,5